

Ordering Code: 61XX-X-XXX-XXX

Example: 6113-5C-2MM-150

Series	O-ring	Material	Connection	Crack Pressure
6100	03 - Viton	2 - Brass	1MM - 1/8" Male NPT x 1/8" Male NPT	.5-250 psi
	07 - Neoprene	5 - 303 SST	2MM - 1/4" Male NPT x 1/4" Male NPT	
	13 - Buna	5C - 316 SST	3MM - 3/8" Male NPT x 3/8" Male NPT	
	20 - Teflon		4MM - 1/2" Male NPT x 1/2" Male NPT	
	24 - Silicone		6MM - 3/4" Male NPT x 3/4" Male NPT	
	26 - Fluorosilicone		8MM - 1" Male NPT x 1" Male NPT	
	32 - Ethylene Propylene		1P2M - 1/8" Female NPT x 1/4" Male NPT	
	35 - Kalrez		2PM - 1/4" Female NPT x 1/4" Male NPT	
			2MP - 1/4" Male NPT x 1/4" Female NPT	

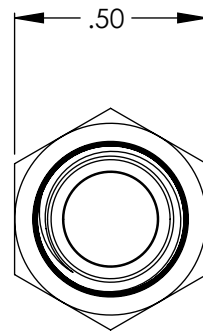
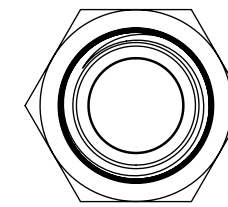
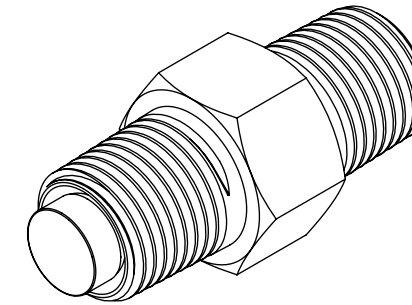

6100 Series - 1MM

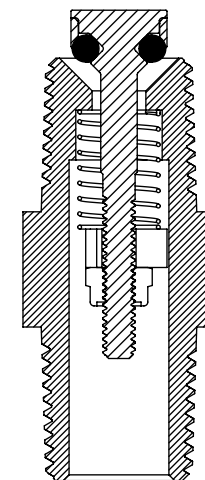
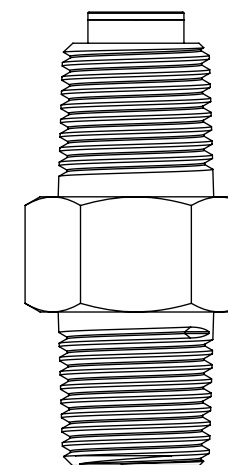
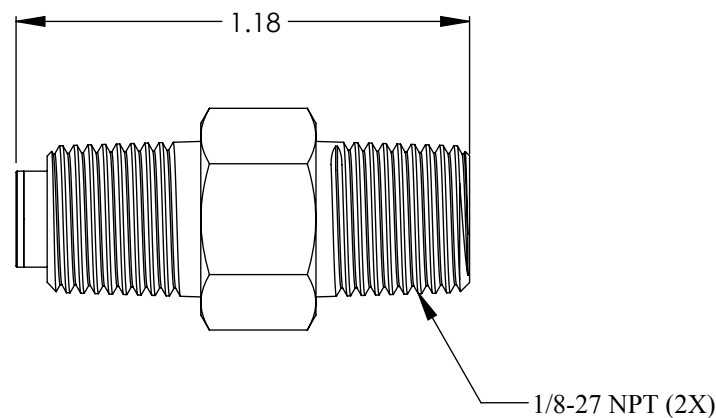

↑
Flow

Body Material: Brass*, 303 SST*, 316 SST*

O-ring Material: Buna-N**, Ethylene Propylene**, Viton**, Teflon**, Neoprene, Silicone, Aflas, Fluorosilicone, Kalrez

Spring Material: 302 SST - Any other spring materials consult factory

Operating Pressure: Vacuum to 3000 psig (207 bar)

Cracking Pressure: .5 to 250 psig (.034 bar to 17.2 bar) - Any crack pressure above or below standard crack pressure range consult factory

Temperature Range: -70°F to +400°F (-56°C to +204°C) - Based on o-ring and body material

Connection Sizes: (1/8" MNPT x 1/8" MNPT to 1" MNPT x 1" MNPT)***, (1/8" FNPT x 1/4" MNPT and 1/4" MNPT x 1/4" FNPT)***

* Standard body materials; Consult factory for availability of other body material

** Standard o-ring materials; Consult factory for availability of other o-ring material

***Standard connections sizes; Consult factory for availability of other connection sizes

Note: Proper filtration is recommended to prevent damage to the o-ring or sealing surface

VALVE CHECK		
6100 Series Inline Check Valve - 1MM		
SIZE B	Sales Drawing	REV A