

Ordering Code: 62XX-X-XX-XX

Example: 6203-2-3MM-1

Series	O-ring	Material	Connection	Crack Pressure
6200	03 - Viton 07 - Neoprene 13 - Buna 24 - Silicone 26 - Fluorosilicone 32 - Ethylene Propylene 35 - Kalrez	2 - Brass 5 - 303 SST 5C - 316 SST	1MM - 1/8" Male NPT 1/8" Male NPT 1MP - 1/8" Male NPT 1/8" Female NPT 1PM - 1/8" Female NPT 1/8" Male NPT 1PP - 1/8" Female NPT 1/8" Female NPT 2MM - 1/4" Male NPT 1/4" Male NPT 2MP - 1/4" Male NPT 1/4" Female NPT 2PM - 1/4" Female NPT 1/4" Male NPT 3MM - 3/8" Male NPT 3/8" Male NPT 4MM - 1/2" Male NPT 1/2" Male NPT 6MM - 3/4" Male NPT 3/4" Male NPT	.5-10 psi

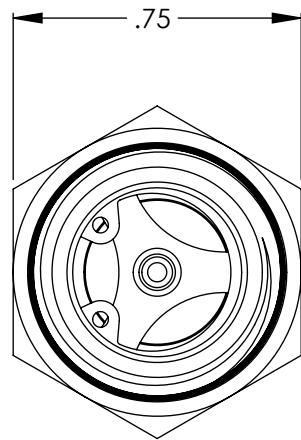
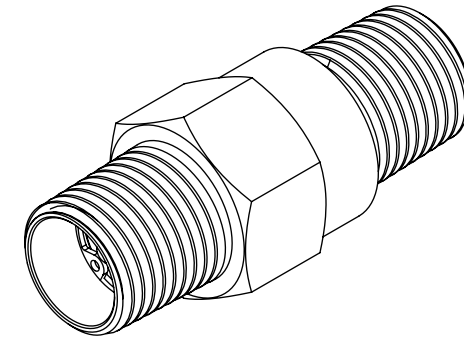

6200 Series - 3MM

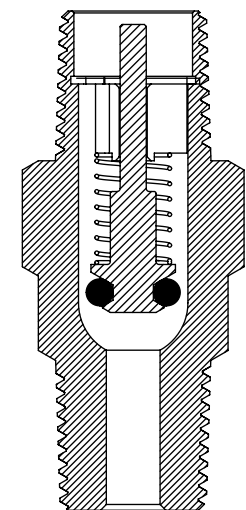
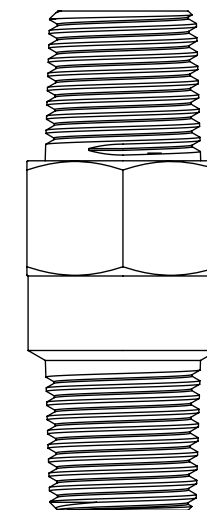
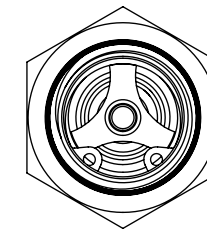
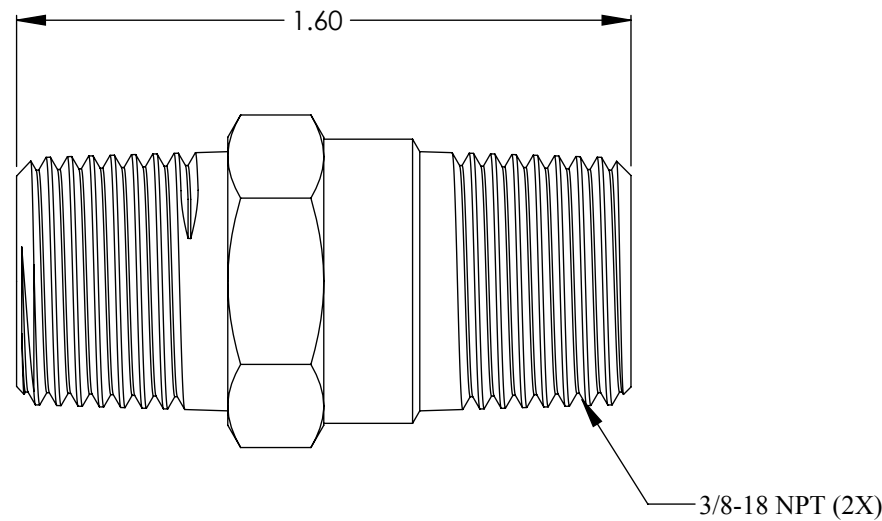

↑
Flow

Body Material: Brass*, 303 SST*, 316 SST*

O-ring Material: Buna-N**, Ethylene Propylene**, Viton**, Neoprene, Silicone, Aflas, Florosilicone, Kalrez

Snap Ring: 17-4 SST

Spring Material: 302 SST - Any other spring materials consult factory

Operating Pressure: Vacuum to 800 psig (55.1 bar)

Cracking Pressure: .5 to 10 psig (.034 bar to .69 bar) - Any crack pressure above or below standard crack pressure range consult factory

Cracking Pressure Tolerance: < 2 psig (.14 bar): +/- 10% , 2 to 10 psig (.14 - .69 bar): +/- 5%

Temperature Range: -70°F to +400°F (-56°C to +204°C) - Based on o-ring and body material

Connection Sizes: (1/8" NPT to 1" NPT)***

* Standard body materials; Consult factory for availability of other body material

** Standard o-ring materials; Consult factory for availability of other o-ring material

*** Standard connections sizes; Consult factory for availability of other connection sizes

Note: 1. Proper filtration is recommended to prevent damage to the o-ring or sealing surface
2. Valve may be assembled with o-rings lubricated with Krytox grease

VALVE CHECK		
6200 Series Inline Check Valve - 3MM		
SIZE B	Sales Drawing	REV A