

Ordering Code: 6XX-X-XXX-XX  
 Example: 603-2-4PP-5

Series	O-ring	Material	Connection	Crack Pressure
600	03 - Viton 07 - Neoprene 13 - Buna 20 - Teflon 24 - Silicone 26 - Fluorosilicone 32 - Ethylene Propylene 35 - Kalrez	1C - Aluminum 2 - Brass 5 - 303 SST 5C - 316 SST 4B - 12L154	1PP - 1/8" Female NPT x 1/8" Female NPT 2PP - 1/4" Female NPT x 1/4" Female NPT 3PP - 3/8" Female NPT x 3/8" Female NPT 4PP - 1/2" Female NPT x 1/2" Female NPT 6PP - 3/4" Female NPT x 3/4" Female NPT 8PP - 1" Female NPT x 1" Female NPT 12PP - 1-1/2" Female NPT x 1-1/2" Female NPT 16PP - 2" Female NPT x 2" Female NPT	.5-5 psi

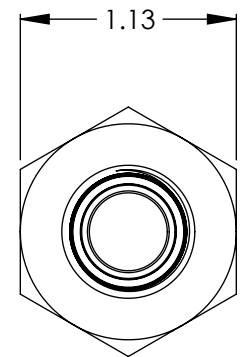

600 Series - 3PP

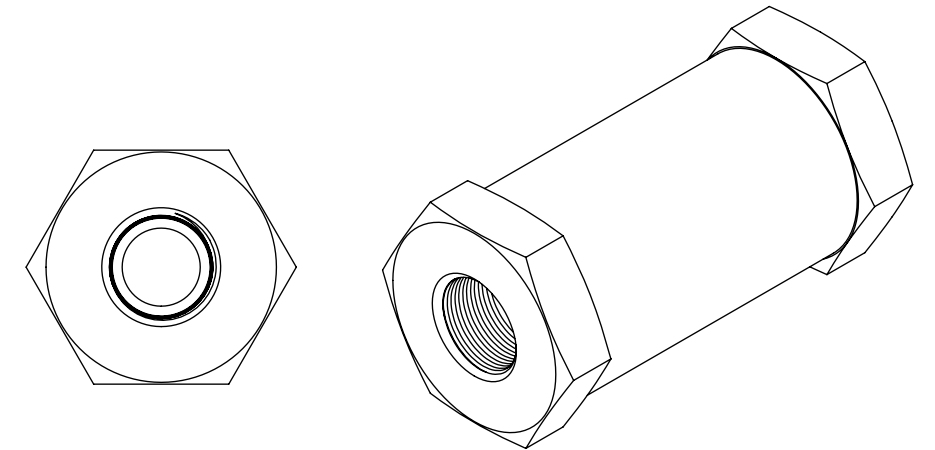
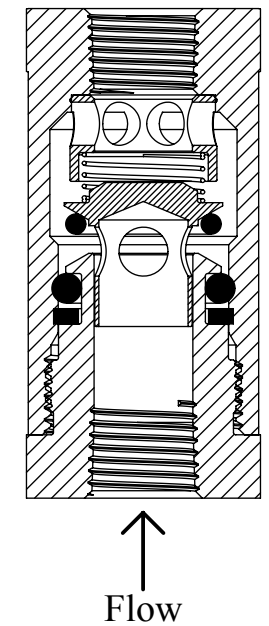
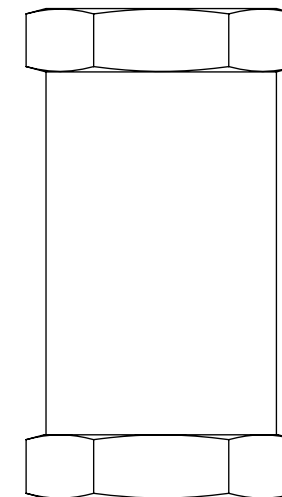
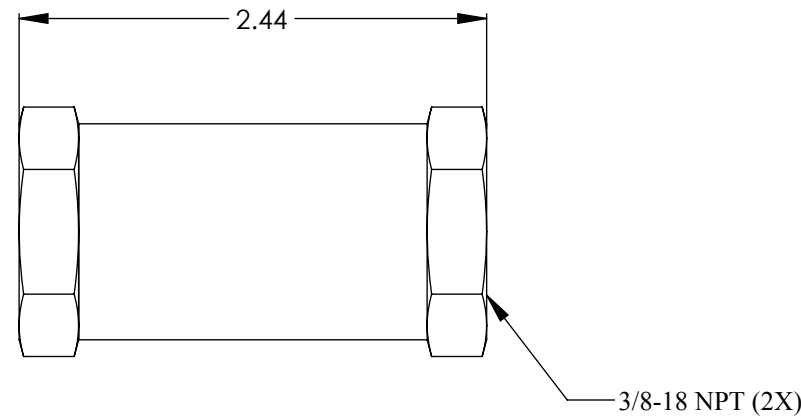

**Body Material:** Aluminum\*, Brass\*, 303 SST, 316 SST\*, 12L14  
**O-ring Material:** Buna-N\*\*, Ethylene Propylene\*\*, Viton\*\*, Neoprene, Silicone, Aflas, Teflon, Florosilicone, Kalrez  
**Spring Material:** 302 SST - Any other spring materials consult factory  
**Operating Pressure:** Vacuum to 3000 psig (206.8 bar) / 2" NPT Brass Maximum 1500 psig (103.4 bar)  
**Cracking Pressure:** .5 to 5 psig (.034 bar to .34 bar) - Any crack pressure above or below standard crack pressure range consult factory  
**Cracking Pressure Tolerance:** < 2 psig (.14 bar): +/- 10% , 2 to 5 psig (.14 - .34 bar): +/- 5%  
**Temperature Range:** -70°F to +400°F (-56°C to +204°C) - Based on o-ring and body material  
**Connection Sizes:** (1/8" FNPT to 2" FNPT)\*\*\*

\* Standard body materials; Consult factory for availability of other body material  
 \*\* Standard o-ring materials; Consult factory for availability of other o-ring material  
 \*\*\* Standard connections sizes; Consult factory for availability of other connection sizes

Note: 1. Proper filtration is recommended to prevent damage to the o-ring or sealing surface  
 2. Valve may be assembled with o-rings lubricated with Krytox grease

<b>VALVE CHECK</b>		
<b>600 Series Inline Check Valve - 3PP</b>		
SIZE <b>B</b>	Sales Drawing	REV <b>A</b>